

I enlarged view

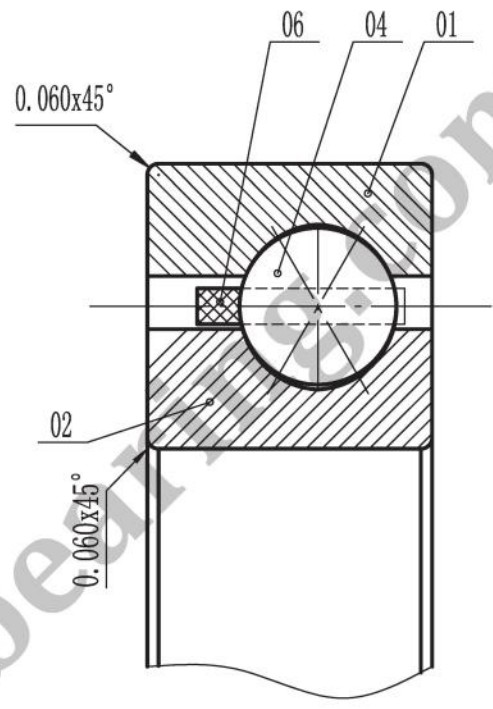

SILVER THIN SECTION BEARING

Formal drawing of SD075XP0 will be submitted after contact with:
sales@jcb-bearing.com or sales@thinsectionbearings.com

| 06 | cage | | Brass | | | |
|-----|-------------|------|------------------|--------------|-------|--------|
| 04 | steel ball | | AISI 52100 Steel | | | |
| 02 | inner ring | 1 | AISI 52100 Steel | | | |
| 01 | outer ring | 1 | AISI 52100 Steel | | | |
| NO. | designation | qty. | material | unit | total | remark |
| | | | | weight (lbs) | | |

Luoyang JCB Bearing Technology Co., Ltd
 Contact information
 Company Address : No.285 Fenghua road, Luoyang, Henan,China.
 Postal code : 471000
 Phone : 0086-379-68611678 Fax : 0086-379-68611679
 E-mail: sales@jcb-bearing.com
 Reserved E-mail: sales@thinsectionbearings.com
 Website: <http://www.jcb-bearing.com>
<https://www.thinsectionbearings.com>

| | | | |
|---|--|--------|--------------|
| SD075XP0 | | | |
| | | | weight (lbs) |
| | | | 1.41 |
| total page 1 | | page 1 | |
| Luoyang JCB Bearing Technology Co., Ltd | | | |